

3.1.4 Diaphragmatic behaviour

In general, when there is eccentric loading at a floor, e.g. imposed by the horizontal seismic action, the in-plane rigidity of the slab forces all the in-plane points (therefore all column heads¹ on the slab) to move the same way.

The 3 displacements $\delta_z, \varphi_x, \varphi_y$ of each node belonging to the diaphragm are independent of each other, while the rest $\delta_x, \delta_y, \varphi_z$ are depended on the 3 displacements of point C_T called Center of Elastic Torsion of the diaphragm. Displacements $\delta_{xi}, \delta_{yi}, \varphi_{zi}$ at the point i of the horizontal diaphragm are expressed as:

$$\varphi_{zi} = \varphi_z$$

$$\delta_{xi} = \delta_{xCT} - y_i \cdot \varphi_z$$

$$\delta_{yi} = \delta_{yCT} + x_i \cdot \varphi_z$$

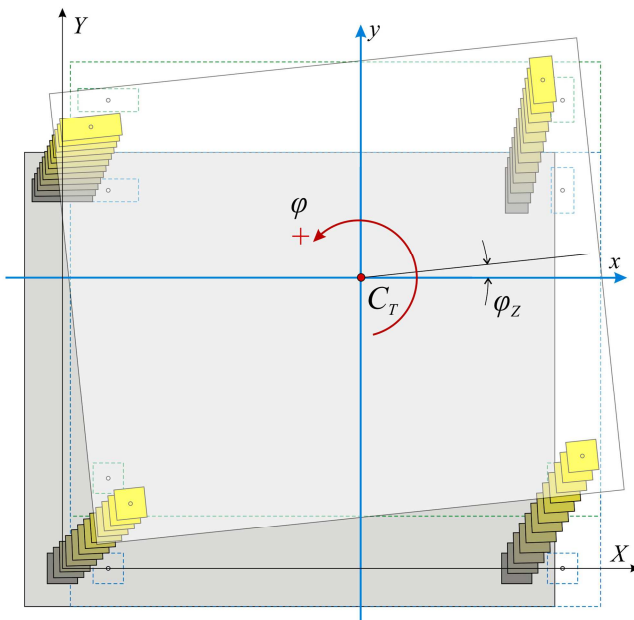
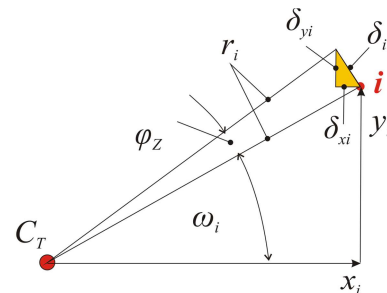

Figure 3.1.4-1: Diaphragmatic behaviour of floor



$$\begin{aligned} \delta_i &= r_i \cdot \varphi_z \\ \delta_{xi} &= -\delta_i \cdot \sin \omega_i \\ \sin \omega_i &= y_i / r_i \\ \delta_{xi} &= -r_i \cdot \varphi_z \cdot y_i / r_i = -y_i \cdot \varphi_z \\ \delta_{yi} &= x_i \cdot \varphi_z \end{aligned}$$

Figure 3.1.4-2: The displacements of a random point i of the diaphragm due to φ_z

In a floor diaphragm of 20 main and 14 slave nodes, the number of the unknown displacements (degrees of freedom) is equal to $20 \times 3 + 3 = 63$.

¹ The term 'column' refers to columns as well as to walls.

is indicated by the red dashed line at the Interface of the related software so that the engineer is able to check the order of magnitude of the distribution of the seismic accelerations. Furthermore, using this method there is no need for additional dynamic response spectrum analysis.

Notes

- The main comparison is performed on seismic accelerations. This is based on the fact that seismic forces provide the same fast visual outcome with respect to their vertical distribution, provided that all floor masses are identical.
- When the principle system is inclined, for earthquake in x direction only, the seismic accelerations are developed in both x, y directions. The same stands for earthquake in y direction only.
- The earthquake in x direction generates components in x direction only when the structure is symmetrical, otherwise it generates components in both directions.

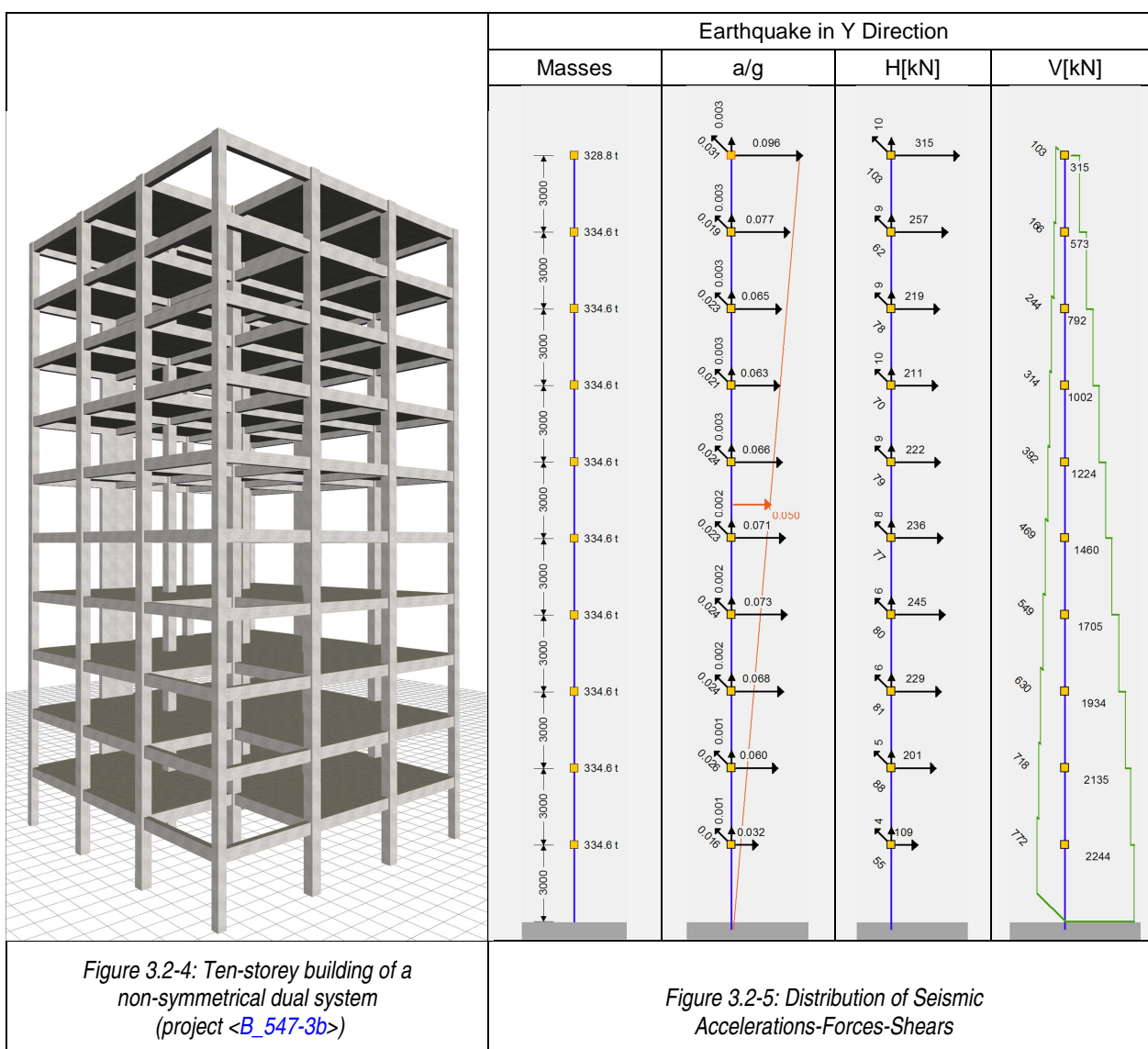

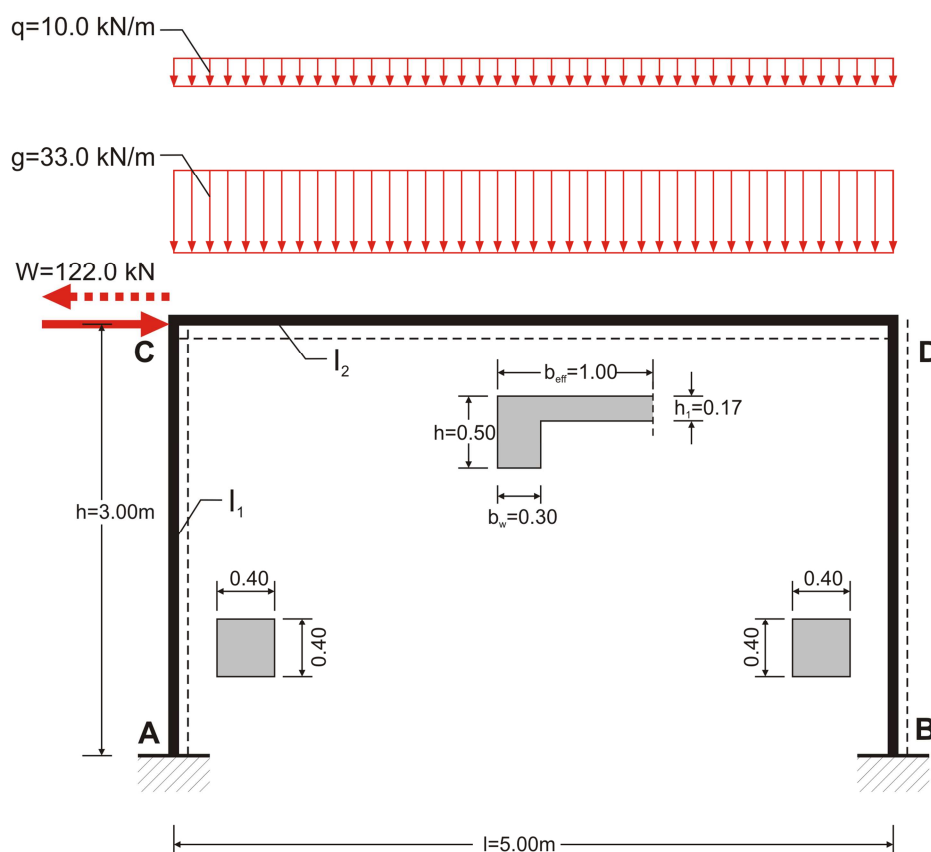

Figure 3.3.3-1: The structural model of the frame considering loadings: g and q and the seismic W

The general analysis of the frame subjected to vertical uniform load w , from table 1 is:

$$k = \frac{I_2 \cdot h}{I_1 \cdot l} = \frac{52.125 \cdot 3.0}{21.33 \cdot 5.0} = 1.47$$

$$H = H_A = -H_B = \frac{l^2}{4h \cdot (k + 2)} \cdot w = \frac{(5.0\text{m})^2}{4 \cdot 3.0\text{m} \cdot (1.47 + 2)} \cdot w = 0.60\text{m} \cdot w,$$

$$V_A = V_B = \frac{l}{2} \cdot w = \frac{5.0\text{m}}{2} \cdot w = 2.50\text{m} \cdot w$$

$$M_A = -M_B = \frac{h}{3} \cdot H = \frac{3.0\text{m}}{3} \cdot 0.60\text{m} \cdot w = 0.60\text{m}^2 \cdot w$$

$$M_{CA} = M_{CD} = M_{DC} = -M_{DB} = -\frac{2}{3} h \cdot H = -\frac{2}{3} \cdot 3.0\text{m} \cdot 0.60\text{m} \cdot w = -1.20\text{m}^2 \cdot w$$

The general analysis of the frame subjected to horizontal load W , from table 39 is:

$$H_A = H_B = -\frac{W}{2} = -0.50W$$

$$V_A = -V_B = -\frac{3 \cdot h \cdot k}{l \cdot (6k + 1)} \cdot W = -\frac{3 \cdot 3.0\text{m} \cdot 1.47}{5.0\text{m} \cdot (6 \cdot 1.47 + 1)} \cdot W = -0.27 \cdot W$$

1st combination: $w = 1.35g + 1.50q = 1.35 \times 33 + 1.50 \times 10.0 = 59.55 \text{ kN/m}$

$$M_A = -M_B = 1.35M_{A,g} + 1.50M_{A,q} = 1.35 \times 19.8 + 1.50 \times 6.0 = 35.7 \text{ kNm}$$

$$M_{CA} = M_{CD} = M_{DC} = -M_{DB} = 1.35M_{CA,g} + 1.50M_{CA,q} = -1.35 \times 39.6 - 1.50 \times 12.0 = -71.5 \text{ kNm},$$

$$H_A = -H_B = 1.35H_{A,g} + 1.50H_{A,q} = 1.35 \times 19.8 + 1.50 \times 6.0 = 35.7 \text{ kN},$$

$$V_A = V_B = 1.35H_{A,g} + 1.50H_{A,q} = 1.35 \times 82.5 + 1.50 \times 25.0 = 148.9 \text{ kN}$$

$$V_{CD} = w \cdot l / 2 + (M_{DC} - M_{CD}) / l = 59.55 \times 5.0 / 2 + (-71.5 + 71.5) / 5.0 = 148.9 \text{ kN},$$

$$V_{DC} = V_{CD} - w \cdot l = 148.9 - 59.55 \times 5.0 = -148.9 \text{ kN}^7$$

$$N_A = -V_{CD} - 1.35 \cdot (\text{self-weight of column}) = -148.9 - 1.35 \times 12.0 = -165.1 \text{ kN}$$

$$N_B = V_{DC} - 1.35 \cdot (\text{self-weight of column}) = -148.9 - 1.35 \times 12.0 = -165.1 \text{ kN}$$

$$x = V_{CD} / w = 148.9 / 59.55 = 2.50 \text{ m}^8, \quad M_{max} = M_{CD} + (V_{CD} \cdot x) / 2 = -71.5 + (148.9 \times 2.50) / 2 = 114.6 \text{ kNm}^9,$$

$$w \cdot l^2 / 8 = 59.55 \times 5.0^2 / 8 = 186.1 \text{ kNm}$$

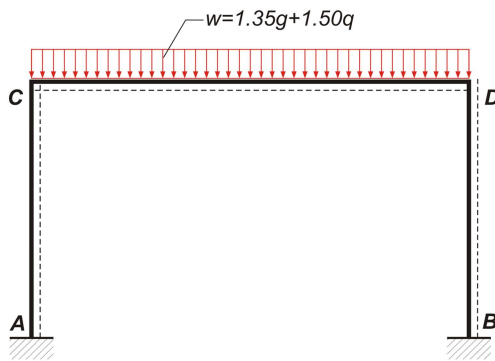

Figure 3.3.3-2

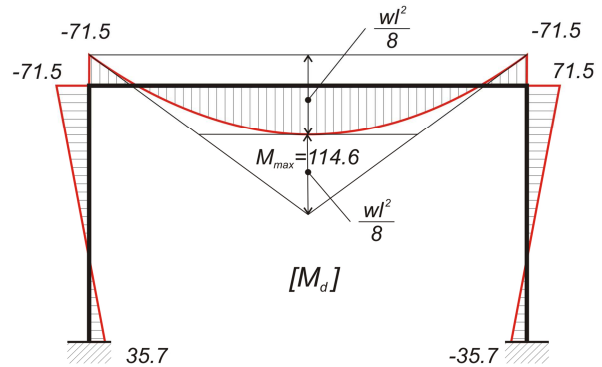

Figure 3.3.3-3

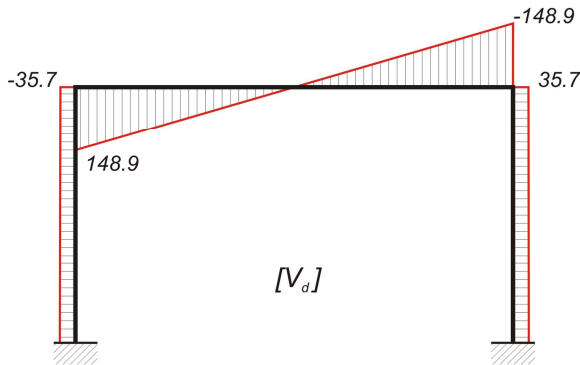

Figure 3.3.3-4

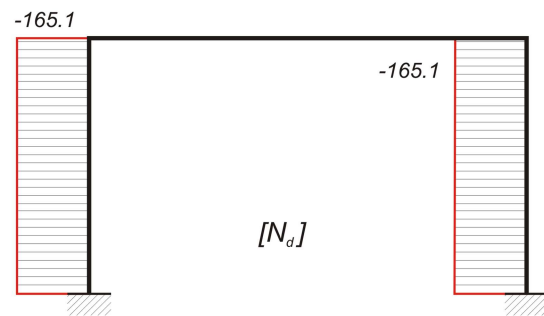

Figure 3.3.3-5

⁷ This stress resultant, as well as most of the following, could be calculated by the simple observation of the symmetry both of structure and loading. However this general process is handling asymmetries as well, e.g. as in the 2nd loading.

⁸ x is the point of zero shear force corresponding to position of maximum bending moment.

⁹ From structural analysis it is known that the maximum bending moment M_{max} in a span i,j is located at the point m at distance x from the end i , where shear forces become zero. The moment at that point is given by the expression $M_{max} = M_{i,j} + A_V$ where A_V is the area under the shear forces diagram from the point i to the point m . In this example, since there is only uniform load, the area is $A_V = (V_{i,j} \cdot x) / 2$.

2nd combination: $w = g + 0.30q + "E_x" = 33.0 + 0.30 \times 10.0 + "E_x" = 36.0 \text{ kN/m} + "E_x"$

$$M_A = M_{A,g} + 0.30M_{A,q} + M_{A,W} = 19.8 + 0.30 \times 6.0 - 100.8 = -79.2 \text{ kNm}, M_B = -19.8 - 0.30 \times 6.0 - 100.8 = -122.4 \text{ kNm}$$

$$M_{CA} = M_{CD} = -39.6 - 0.30 \times 12.0 + 82.2 = 39.0 \text{ kNm},$$

$$M_{DC} = -39.6 - 0.30 \times 12.0 - 82.2 = -125.4 \text{ kNm}, M_{DB} = 39.6 + 0.30 \times 12.0 + 82.2 = 125.4 \text{ kNm},$$

$$H_A = H_{A,g} + 0.30H_{A,q} + H_{A,W} = 19.8 + 0.30 \times 6.0 - 61.0 = -39.4 \text{ kN}, H_B = -19.8 - 0.30 \times 6.0 - 61.0 = -82.6 \text{ kN},$$

$$V_A = V_{A,g} + 0.30V_{A,q} + V_{A,W} = 82.5 + 0.30 \times 25.0 - 32.9 = 57.1 \text{ kN}, V_B = 82.5 + 0.30 \times 25.0 + 32.9 = 122.9 \text{ kN}$$

$$V_{CD} = w \cdot l / 2 + (M_{DC} - M_{CD}) / l = 36.0 \times 5.0 / 2 + (-125.4 - 39.4) / 5.0 = 90.0 - 33.0 = 57.0 \text{ kN},$$

$$V_{DC} = V_{CD} - w \cdot l = 57.0 - 36.0 \times 5.0 = -123.0 \text{ kN}$$

$$N_A = -V_{CD} - \text{self-weight of column} = -57.0 - 12.0 = -69.0 \text{ kN}$$

$$N_B = V_{DC} - \text{self-weight of column} = -123.0 - 12.0 = -135.0 \text{ kN}$$

$$x = V_{CD} / w = 57.0 / 36.0 = 1.58 \text{ m}, M_{\max} = M_{CD} + (V_{CD} \cdot x) / 2 = 39.0 + (57.0 \times 1.58) / 2 = 84.0 \text{ kNm},$$

$$w \cdot l^2 / 8 = 36.0 \times 5.0^2 / 8 = 112.5 \text{ kNm}$$

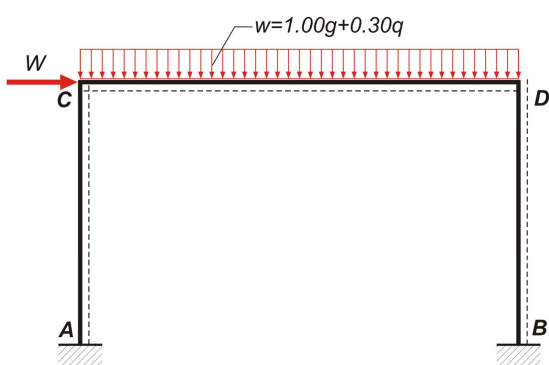

Figure 3.3.3-6

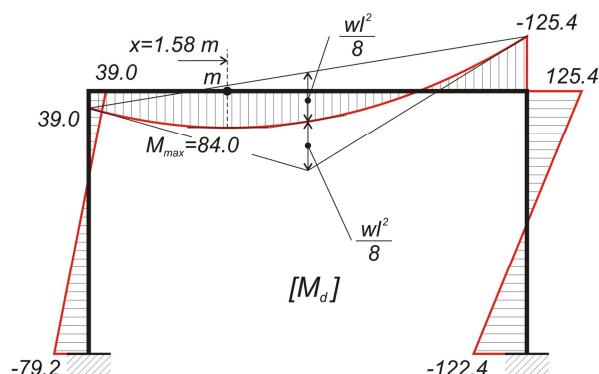

Figure 3.3.3-7

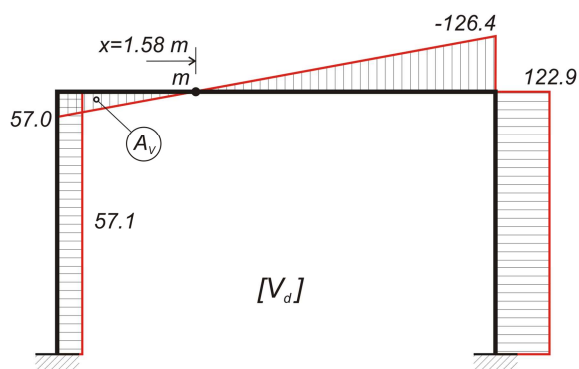

Figure 3.3.3-8

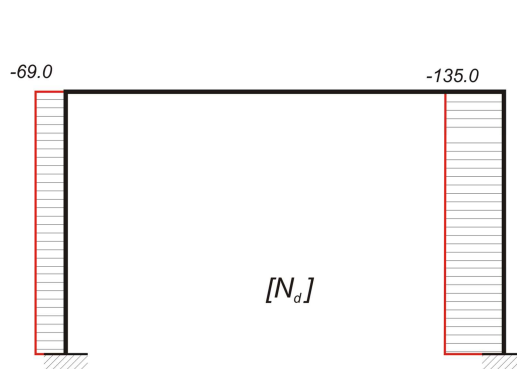

Figure 3.3.3-9

Combinations and Envelopes of stress resultants

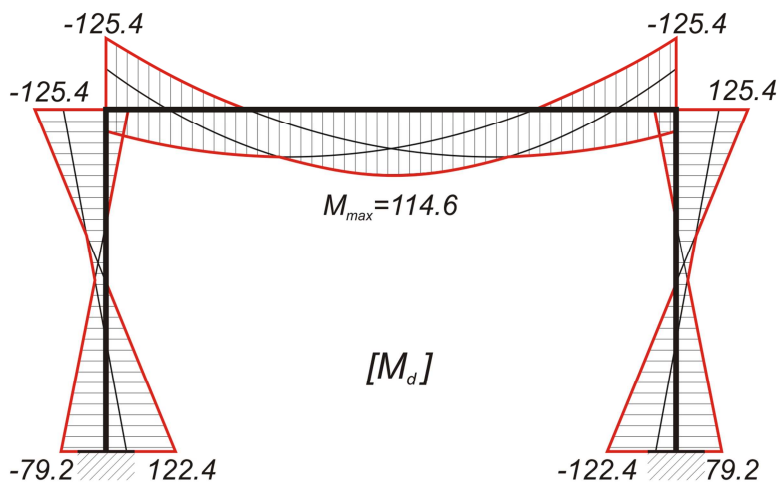

Figure 3.3.3-14

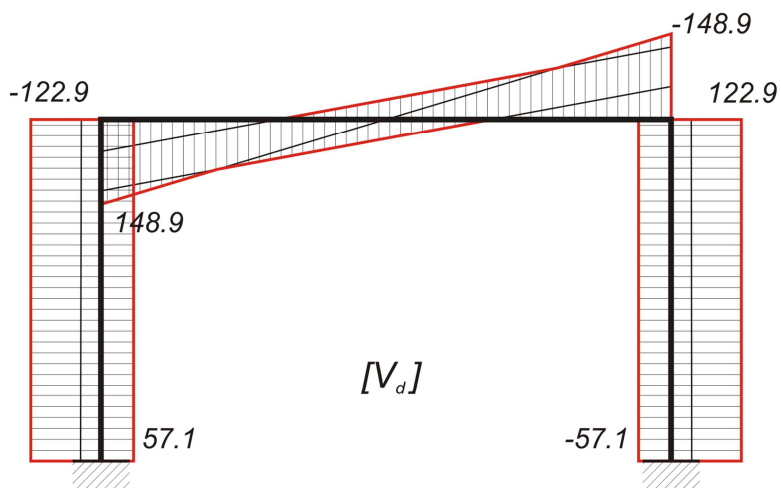

Figure 3.3.3-15

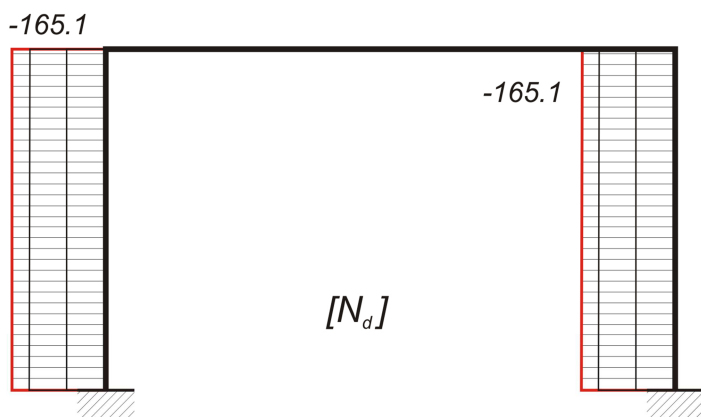

Figure 3.3.3-16

3rd combination: $g+0.30q-E_x$ (additional combination U2)

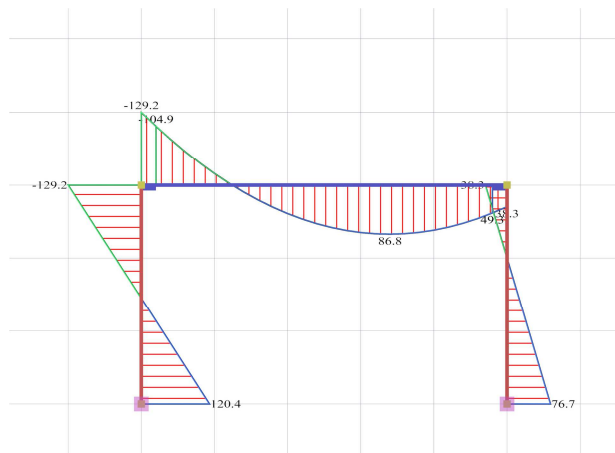

Figure 3.3.3-22:
Bending moment diagram and elastic line

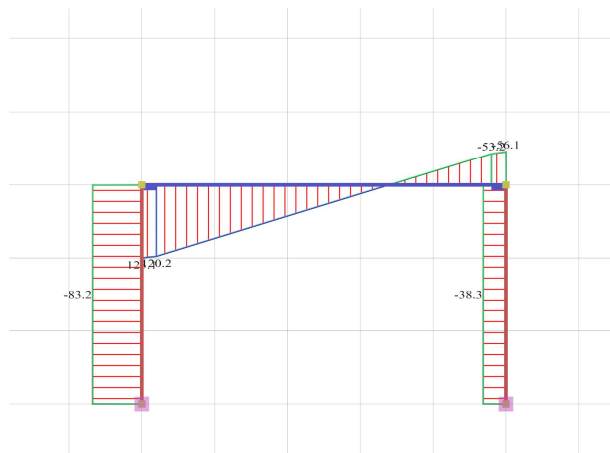

Figure 3.3.3-23:
Shear force diagram

Combinations and Envelopes of Bending Moments

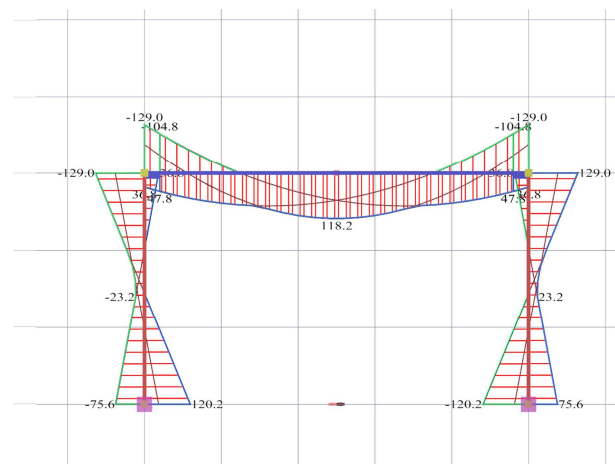

Figure 3.3.3-24:
The three combinations of bending moments

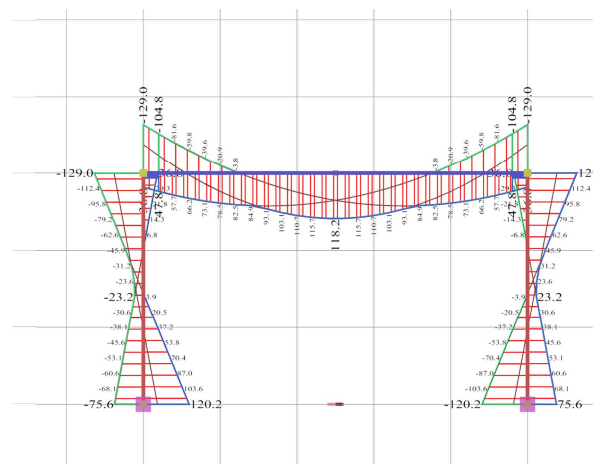

Figure 3.3.3-25: Envelope of bending moments.
The values given per 0.20 m are needed for the reinforcement design and the reinforcement detailing

3.3.6 Modelling slabs using members and finite elements

Finite element method assists in defining slabs behaviour with significant accuracy. However, in order for the results to represent the reality, suitable assumptions should be adopted. The effects of the following factors are examined thoroughly in Appendix A:

- 1) The frame behaviour at the regions close to columns
- 2) The deflection of beams
- 3) The torsional stiffness of beams

The above factors affect the behaviour of slabs. In order to investigate this effect, a simple structure is being modelled in two ways:

- (i) Using members, according to which the slab is modelled as a grid of main and secondary joists, without the assumption of rigid bodies.
- (ii) Using triangular finite elements.

The summary of Appendix A is presented below:

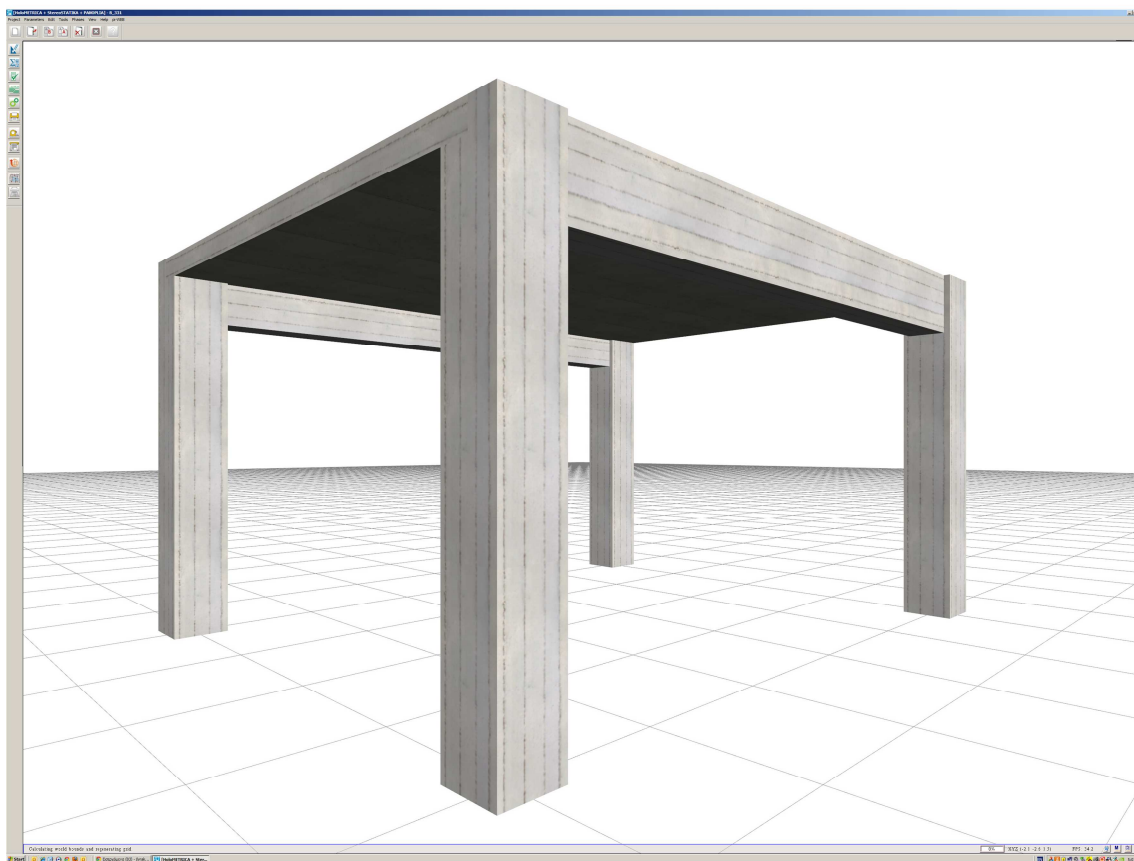

Figure 3.3.6-1: The structure of project <B_331> of the related software (column sections 400/400, beam sections 300/500, slab thickness 170 mm)

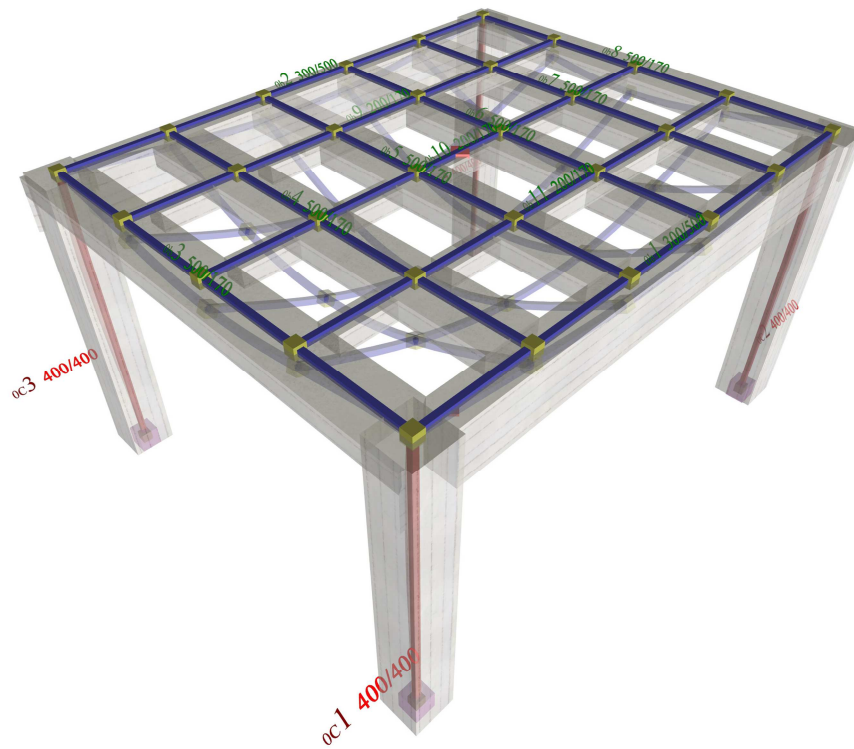

Figure 3.3.6-2: Slab modelled with members and the displaced structure (project <B_336>)

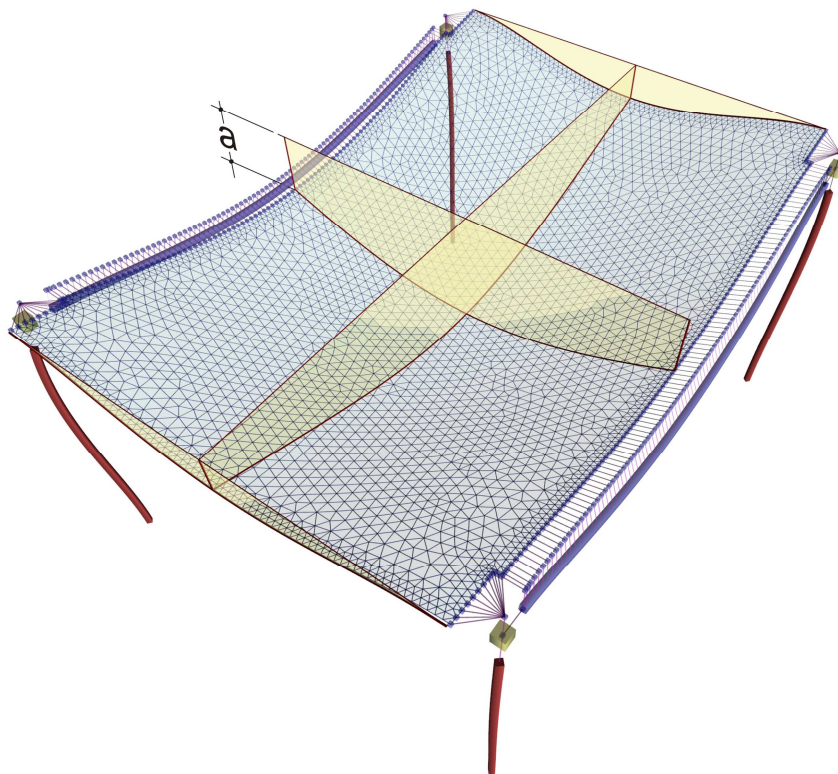

Figure 3.3.6-3: Slab modelled with triangular finite elements (project <B_331>, pi-FES) (a=beam-slab common deflection curve)

3.3.6.1 The frame behaviour in regions of columns

The model using both members and more accurate two-dimensional finite elements, takes into account the **slab frame behaviour in regions close to columns**, in contrast to the inexpensive approach of simply supported slab throughout its length. However, in order for the slab to behave as a common frame with the columns in the actual structure, the slab-columns connections (where strong negative bending moments are developed) should be reinforced with strong, correctly placed and well anchored negative top reinforcement at slabs. For this reason, the slab analysis using finite elements in common worksheets should consider pinned supports on columns.

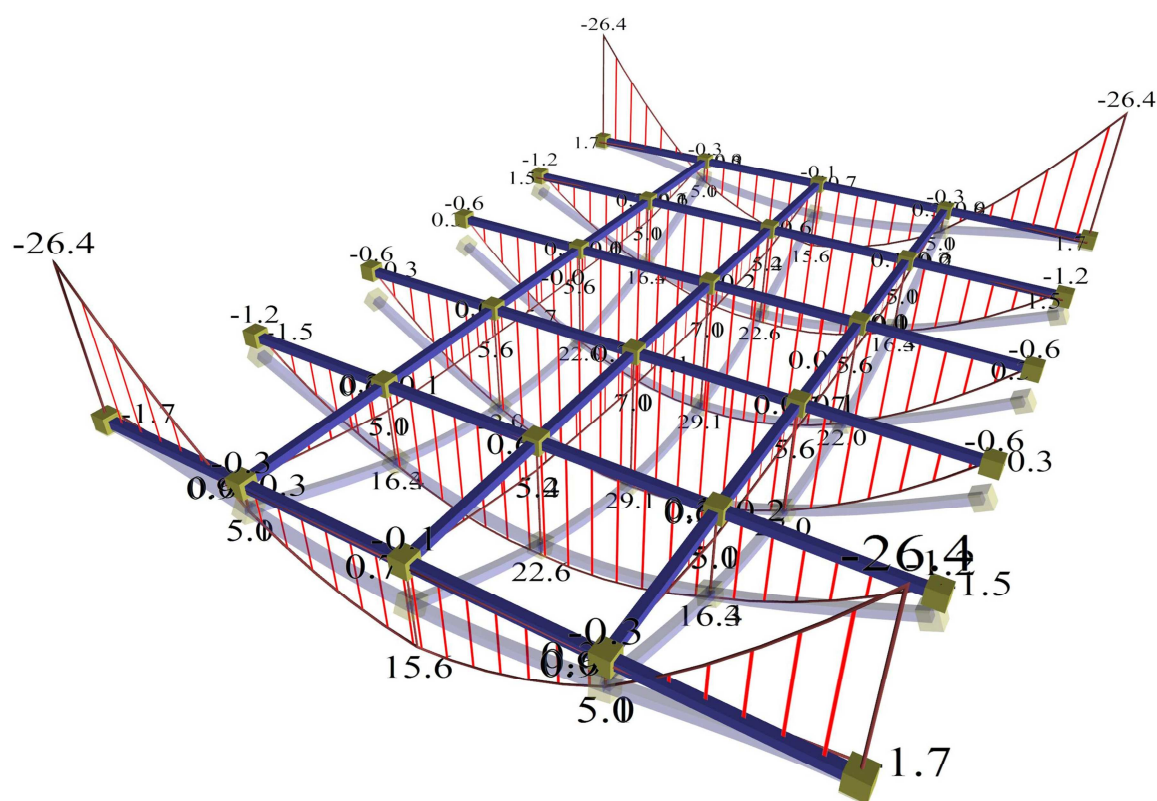

Figure 3.3.6.1-1: Bending moment diagrams of joists of structure modelled with members (project <B_336>)

In case of members, the two main side joists (of slab) forming a common frame with the columns, have greater torsional rigidity than the intermediate nearly simply supported main joists and bear heavier loads, thereby to develop strong negative bending moments at their supports and relatively low positive bending moments at their spans. The interim main joists develop strong positive bending moments at their spans, while being supported on the end joists through the secondary joists stressed by significant positive bending moments at their spans.

In the more accurate model using two-dimensional finite elements, the main side strips behave intensively as frames. The results are similar to those of using members with the following differences: (a) In the main side strips (corresponding to the main side joists) the frame behaviour is more intensive, since the moments at the supports are greater and moments at the spans are smaller, (b) In the interim main strips (corresponding to the interim main joists) the span moments are smaller, (c) The span moments of the secondary strips (corresponding to secondary joists) end up to be greater. This is due to the fact that the internal torsional stiffness of the slab elements (torsion) is stronger than the respective of members.

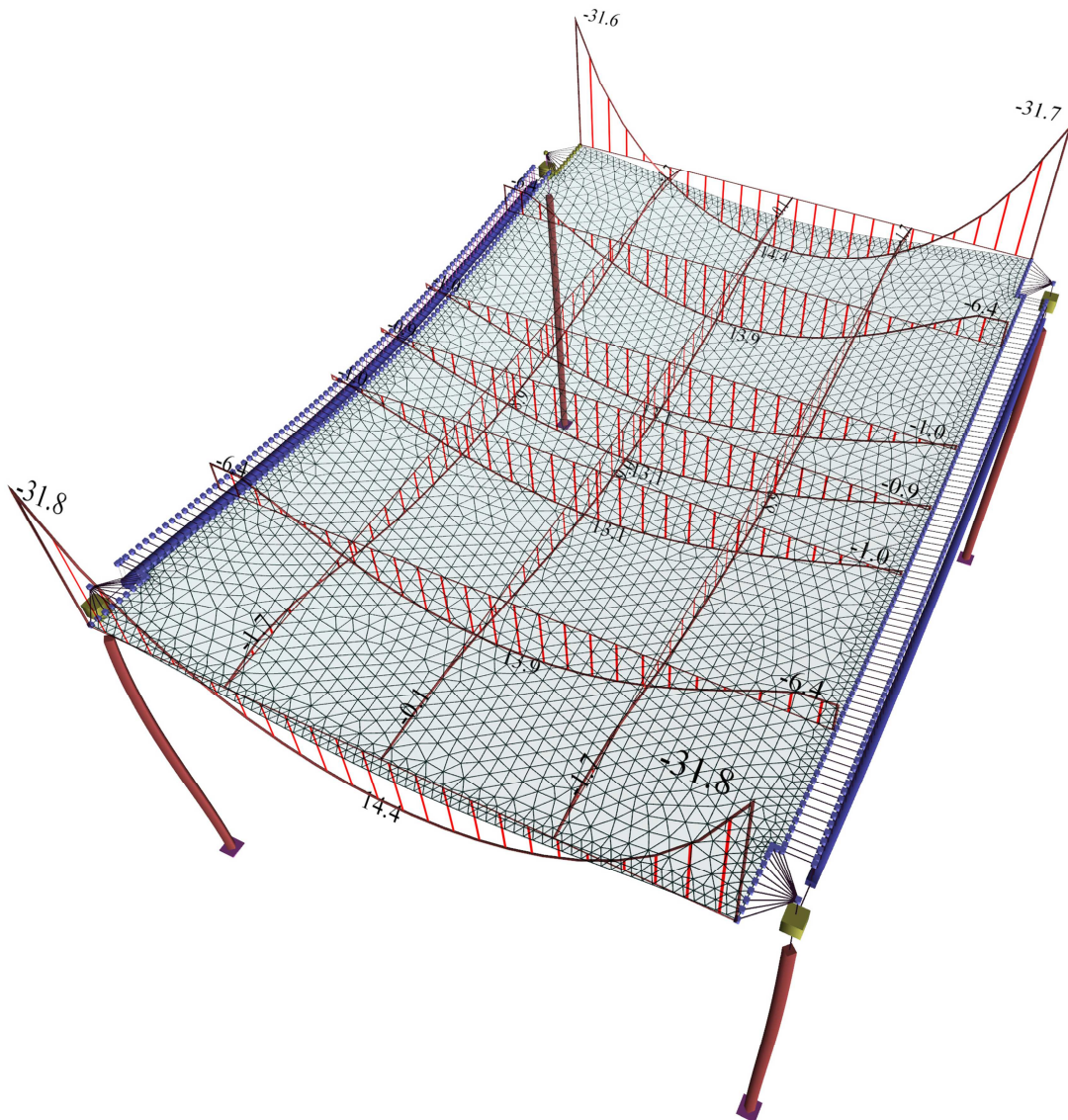

Figure 3.3.6.1-2: Bending moment diagrams of slab strips modelled with triangular finite elements (project <B_331>, pi-FES)